

LED Panel Light

Manufacturer: Shenzhen Crep Optoelectronics Co., Ltd.

Description: Round Surface Mounted P17

Code: CPS-Y8A18-P17

CPS-Y8E24-P17

CPS-Y12A24-P17

CPS-Y12E24-P17



1. Features

- Elegant and ultra-thin design, 18mm thickness;
- Powerful functions: simple version, induction version, switchable CCT changed version;
- Indoor IP44, wide range of applications: corridors, office, lobby or kitchen, bathroom, Home bedroom, etc.);
- To replace the traditional ceiling lamp, brings new concept of functional and modern decoration simple style, and with advantages of small size, DIY installation, low transport costs, saving stock fees.

2. Technical Parameter

Item	Unit	CPS-Y8A18-P17	CPS-Y8E18-P17	CPS-Y12A24-P17	CPS-Y12E24-P17
Electrical Characteristics					
Input	V	AC220-240V	AC220-240V	AC220-240V	AC220-240V
Rate	Hz	50/60Hz	50/60Hz	50/60Hz	50/60Hz
Power	W	18±8%	18±8%	24±8%	24±8%
Input Current (max)	A	0.16	0.16	0.22	0.22
Power Factor	PF	≥0.9	≥0.9	≥0.9	≥0.9
Flickering	--	No Flickering	No Flickering	No Flickering	No Flickering
IP Class	--	IP20	IP20	IP20	IP20
Certification	--	CE	CE	CE	CE
Optical Characteristics					
LED QTY	PCS	56	56	90	90
LED Type	--	SMD 2835	SMD 2835	SMD 2835	SMD 2835
Lightening Way	--	Side-emitting	Side-emitting	Side-emitting	Side-emitting
Beam Angle	Degree	120±10°	120±10°	120±10°	120±10°
Luminous Flux	LM	1600±8%	1600±8%	2100±8%	2100±8%
Efficiency	LM/W	85LM/W	85LM/W	85LM/W	85LM/W
CCT	K	2700K~6500K	2700K~6500K	3000K/4000K/5700K	3000K/4000K/5700K
CRI	Ra	≥80	≥80	≥80	≥80

Working Environment					
Working TEM	°C	-20~45°C	-20~45°C	-20~45°C	-20~45°C
Working Humidity	RH	0~90%	0~90%	0~90%	0~90%
Storage TEM	°C	-20~50°C	-20~50°C	-20~50°C	-20~50°C
Storage Humidity	RH	0~60%	0~60%	0~60%	0~60%
Design Lifespan	H	>40000	>40000	>40000	>40000
Usage Lifespan	H	>25000	>25000	>25000	>25000
Size/ Package					
Dimension	MM	Φ220x18.8mm	Φ220x18.8mm	Φ330x18.8mm	Φ330x18.8mm
Installation	--	Surface Mounted	Surface Mounted	Surface Mounted	Surface Mounted
Unit Size	MM	226*226*30	226*226*30	336*336*30	336*336*30
Carton Size	MM	340*465*465	340*465*465	475*350*350	475*350*350
QTY/CTN	PCS	40	40	15	15
N.W/PC	KG	0.456	0.456	0.92	0.92
G.W/CTN	KG	19.24	19.24	14.8	14.8

3. Testing

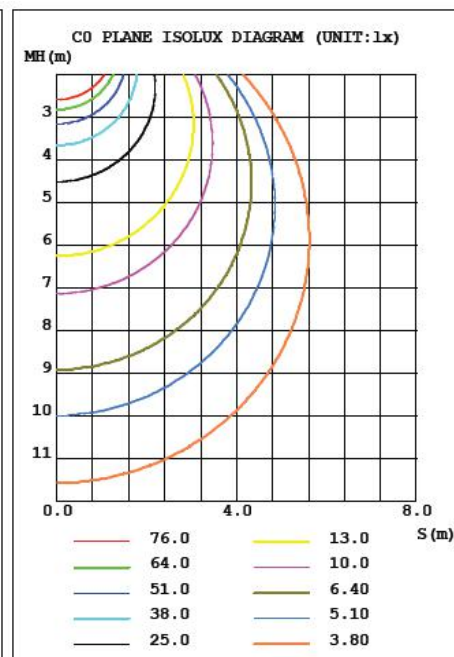
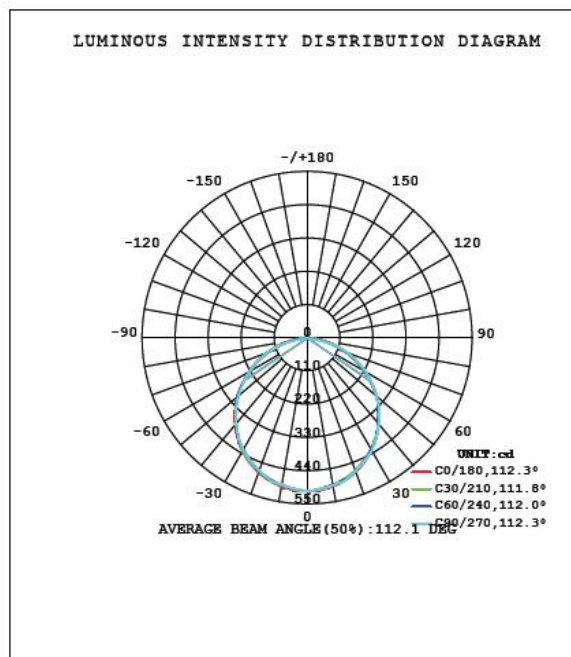

Spectrum Test Report

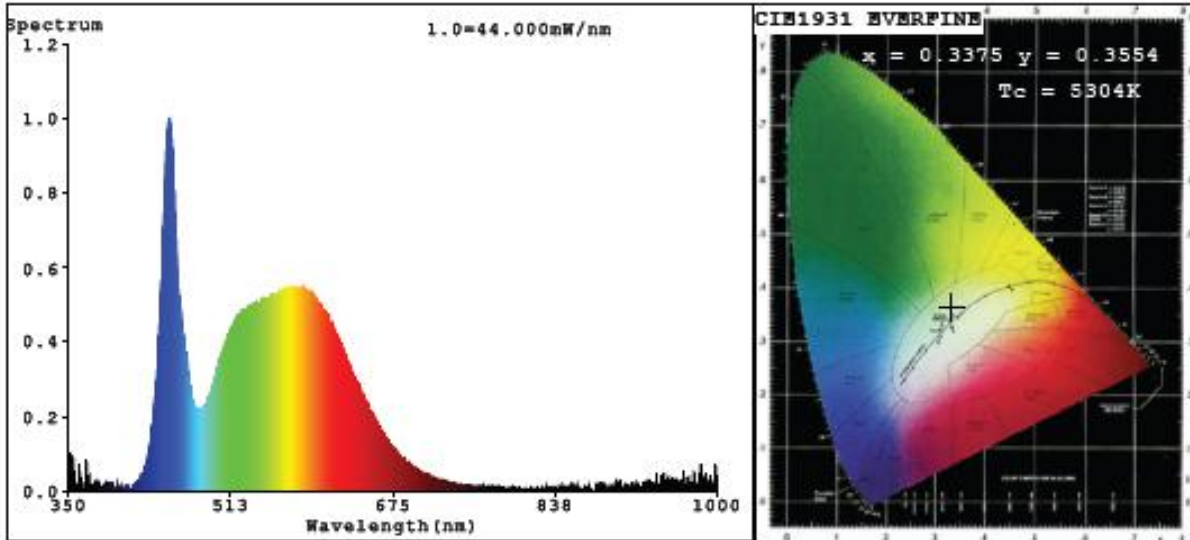

Color Parameters:

Chromaticity Coordinate: $x=0.3375$ $y=0.3554$ / $u'=0.2049$ $v'=0.4854$

$T_c=5304K$ (Duv=0.0050) Dominant WL: $\lambda_d = 561.8nm$ Purity=7.9%

Ratio: R=15.9% G=79.9% B=4.2% Peak WL: $\lambda_p=450.7nm$ FWHM=18.9nm

Render Index: $R_a=81.2$

R1 =79 R2 =86 R3 =92 R4 =81 R5 =80 R6 =81 R7 =86

R8 =64 R9 =0 R10=67 R11=80 R12=57 R13=80 R14=96 R15=72

Photo Parameters:

Flux = 1522 lm Eff. : 80.93 lm/W $F_e = 4.738 W$ Scotopic: 3049.6 S/P: 2.0032

Electrical parameters:

V = 220.4 V I = 0.09332 A P = 18.81 W PF = 0.9147

LEVEL: OUT WHITE: ANSI_5000K

Status: Integral T = 1 ms $I_p = 927 (1\%)$

Model: CPS-Y8A18-P17-857

Tester: Alice Zhang

Temperature: 25.3Deg

Manufactory: CREP

Number: 58

Date: 2017-07-20

Humidity: 48.0%

Remarks:

Temperature Rise curve

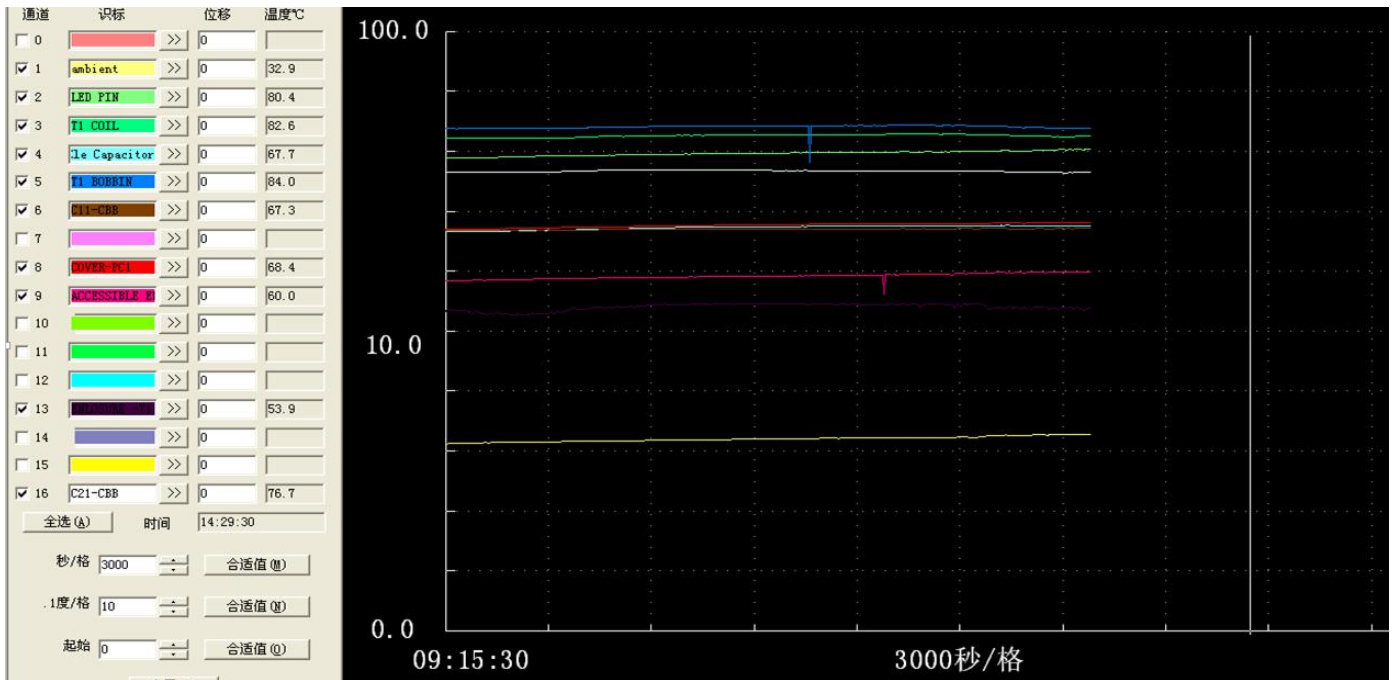

4. Outline and Size

Product Photo



Dimensional Drawing

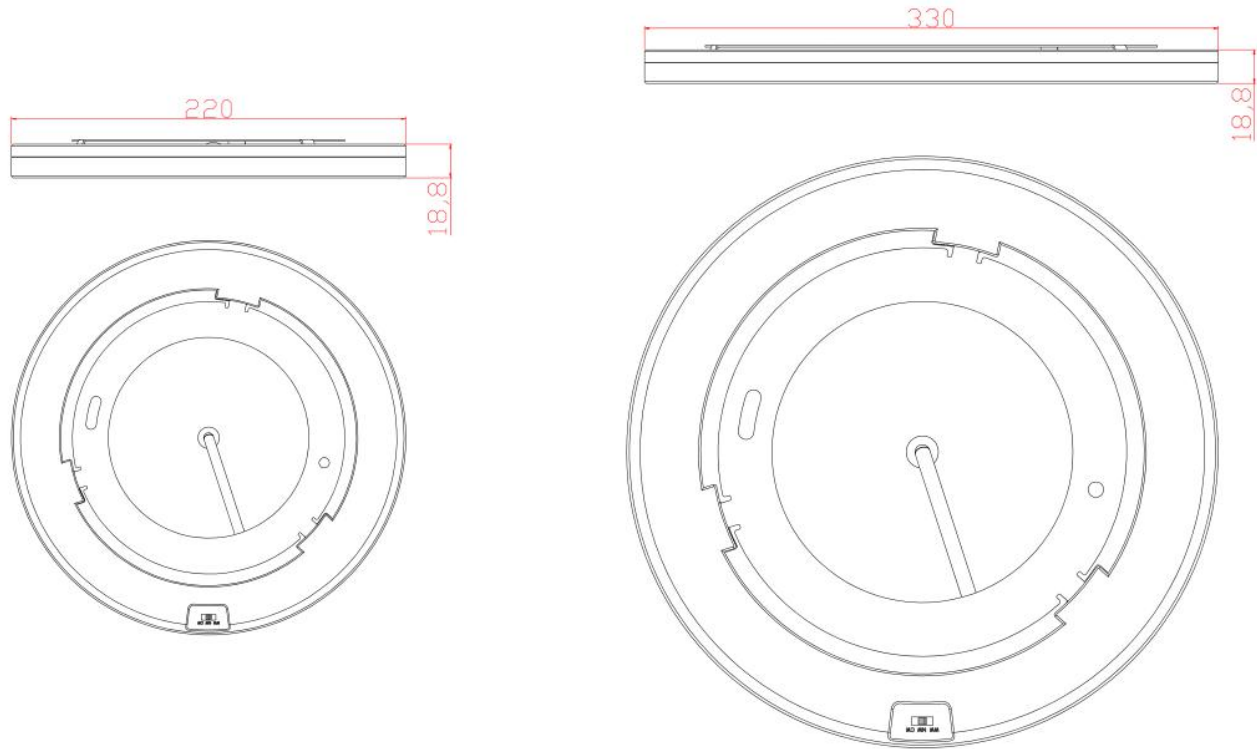

4、Operation

Installation

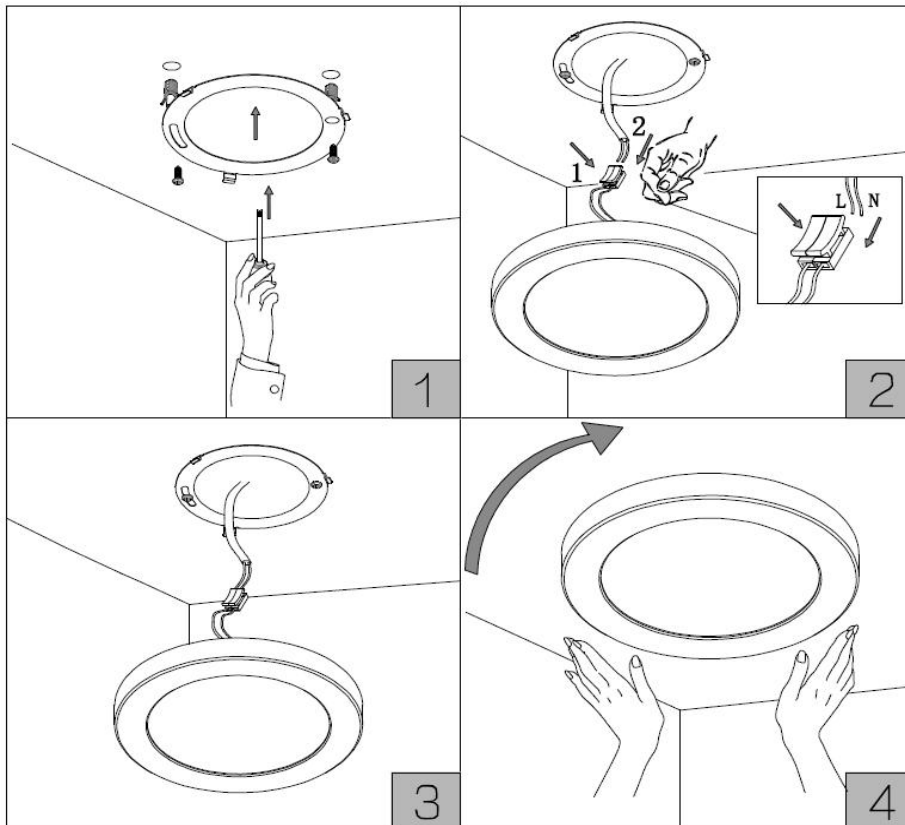

Instruction

- 1, Fixed the holder onto the ceiling with the anchoring.
2. Connect the live wire& null wire to the corresponding wire in the terminal on the fixture.
3. Adjust the angle of the fixture to the latch groove of the bake cove and the holder at the same level.
4. Rotate the fixture to the latch groove to finish the installation.

Connection

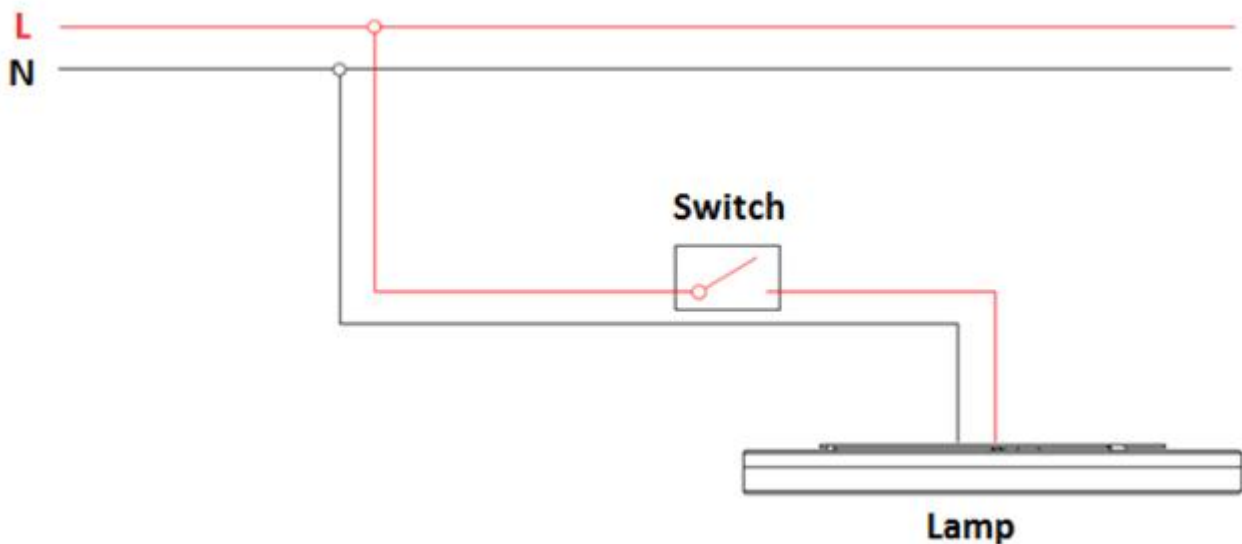

5、 Applications

This product is widely used in engineering lighting, commercial lighting and general lighting.

6、 Cautious

- 1: If the lamp fails to work properly, please check whether the connection is good.
- 2: Please don't install in damp, water leakage, unstable place.
3. Please power off before install or remove.
4. Please follow the right installation.
5. If there is any damage, please get professional maintenance personnel (or after-sales service points).
6. Do not remove the product personally.